

Dreame J30-W

Cordless Stick Vacuum

User Manual

DREAME

THANK YOU

FOR PURCHASING THIS DREAME VACUUM CLEANER.

Registration Quick Start

Welcome to register a Dreame account by scanning the QR code.

You are available for the **User Manual** and Special Offers.



With it you are obtaining a high quality product that is engineered for optimal performance. If you have any questions on the product, please contact us: support.us@dreame.tech.

EN	User Manual -----	1
FR	Manuel d'utilisation -----	24
ES	Manual de Usuario -----	47

Safety Information

IMPORTANT SAFETY INSTRUCTIONS

When using an electrical appliance, basic precautions should always be followed, including the following:

READ ALL INSTRUCTIONS BEFORE USING (THIS APPLIANCE). Failure to follow the warnings and instructions may result in electric shock, fire and/or serious injury.

SAVE THESE INSTRUCTIONS

Household use only.

WARNING – To reduce the risk of fire, electric shock, or injury:

Do not use outdoors or on wet surfaces.

Do not allow to be used as a toy. Close attention is necessary when used by or near children, pets or plants.

Use only as described in this manual. Use only manufacturer's recommended attachments.

Do not use with damaged cord or plug. If appliance is not working as it should, has been dropped, damaged, left outdoors, or dropped into water, return it to a service center.

Do not pull or carry by cord, use cord as a handle, close a door on cord, or pull cord around sharp edges or corners.

Do not run appliance over cord. Keep cord away from heated surfaces.

Do not unplug by pulling on cord. To unplug, grasp the plug, not the cord.

Do not handle charger, including charger plug, and charger terminals with wet hands Do not put any object into openings.

Do not use with any opening blocked; keep free of dust, lint, hair, and anything that may reduce air flow.

Keep hair, loose clothing, fingers, and all parts of body away from openings and moving parts.

Use extra care when cleaning on stairs.

Do not use to pick up flammable or combustible liquids, such as gasoline, or use in areas where they may be present.

Do not pick up anything that is burning or smoking, such as cigarettes, matches, or hot ashes.

Do not use without dust cup and/or filters in place.

Prevent unintentional starting. Ensure the switch is in the off-position before connecting to battery pack, picking up or carrying the appliance. Carrying the appliance with your finger on the switch or

energizing appliance that have the switch on invites accidents.

Disconnect the battery pack from the appliance before making any adjustments, changing accessories, or storing appliance. Such preventive safety measures reduce the risk of starting the appliance accidentally.

Recharge only with the charger specified by the manufacturer. A charger that is suitable for one type of battery pack may create a risk of fire when used with another battery pack.

Use appliances only with specifically designated battery packs. Use of any other battery packs may create a risk of injury and fire.

When battery pack is not in use, keep it away from other metal objects, like paper clips, coins, keys, nails, screws or other small metal objects, that can make a connection from one terminal to another. Shorting the battery terminals together may cause burns or a fire.

Under abusive conditions, liquid may be ejected from the battery; avoid contact. If contact accidentally occurs, flush with water. If liquid contacts eyes, additionally seek medical help. Liquid ejected from the battery may cause irritation or burns.

Do not use a battery pack or appliance that is damaged or modified. Damaged or modified batteries may exhibit unpredictable behavior resulting in fire, explosion or risk of injury.

Do not expose a battery pack or appliance to fire or excessive temperature. Exposure to fire or temperature above 130°C may cause explosion.

Follow all charging instructions and do not charge the battery pack or appliance outside of the temperature range specified in the instructions. Charging improperly or at temperatures outside of the specified range may damage the battery and increase the risk of fire.

Have servicing performed by a qualified repair person using only identical replacement parts. This will ensure that the safety of the product is maintained.

Do not modify or attempt to repair the appliance or the battery pack except as indicated in the instructions for use and care.

Do not use and store in extremely hot or cold environments (below 0°C/32°F or above 40°C/104°F). Please charge the cordless vacuum cleaner in temperature above 0°C/32°F and below 40°C/104°F

Caution:

This device complies with Part 15 of the FCC Rules / Innovation, Science and Economic Development Canada's licence-exempt RSS(s). Operation is subject to the following two conditions:

1. this device may not cause harmful interference.
2. this device must accept any interference received, including interference that may cause undesired operation.

Changes or modifications not expressly approved by the party responsible for compliance could void the user's authority to operate the equipment.

This equipment has been tested and found to comply with the limits for a Class B digital device, pursuant to part 15 of the FCC Rules.

These limits are designed to provide reasonable protection against harmful interference in a residential installation.

This equipment generates uses and can radiate radio frequency energy and, if not installed and used in accordance with the instructions, may cause harmful interference to radio communications.

However, there is no guarantee that interference will not occur in a particular installation.

If this equipment does cause harmful interference to radio or television reception, which can be determined by turning the equipment off and on, the user is encouraged to try to correct the interference by one or more of the following.

— — —	Direct current
~	Alternating current

Product Overview

Accessory List

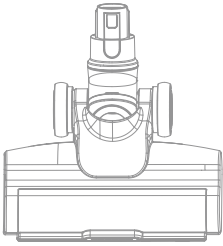

Illumination
multi-surface brush

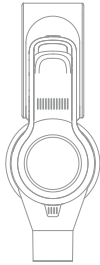

Vacuum body



Crevice nozzle

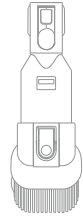

Wide combination
tool



Extension rod

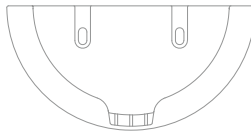

Wall mount

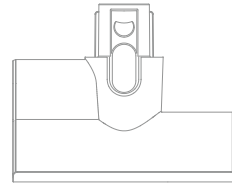

Motorized mini-brush

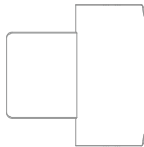

Accessory mount

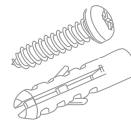

Accessory kit
(screw 2 + expansion tube 3)

Note: The images in this manual are for illustrative purposes only. The actual product may differ.

Product Overview

Component Names

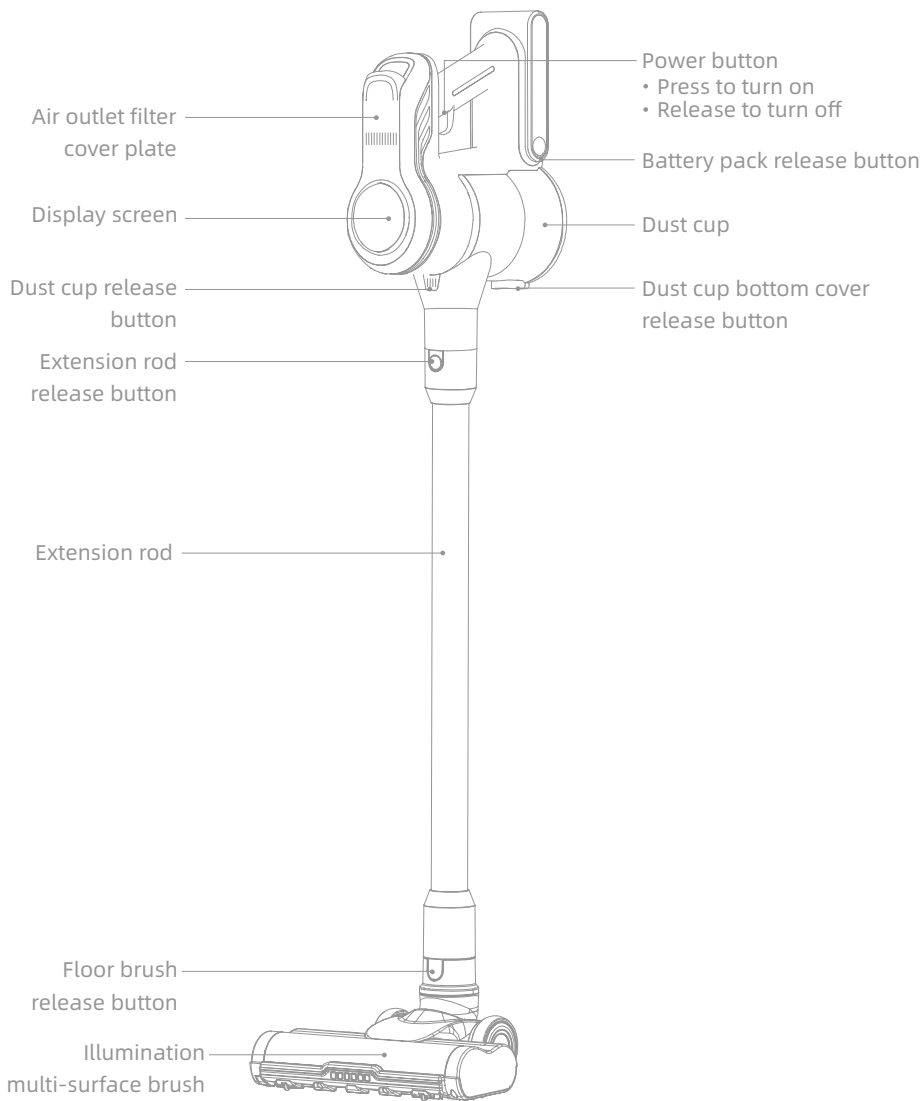

Product Overview

Introduction of Display Screen

-  • Normal numerical display: represents battery level
- E2: Battery pack discharge overcurrent
- E6: Charger voltage or current abnormality
- E7: Discharge no-load protection

 Roller Brush Stuck

-  • Low mode: Start mode displays six grids
- Mid mode: Press once to display twelve grids
- High mode: Press twice to display eighteen grids

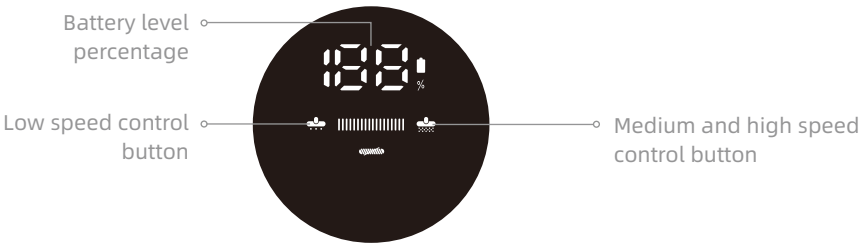

Installation

Vacuum Installation Diagram

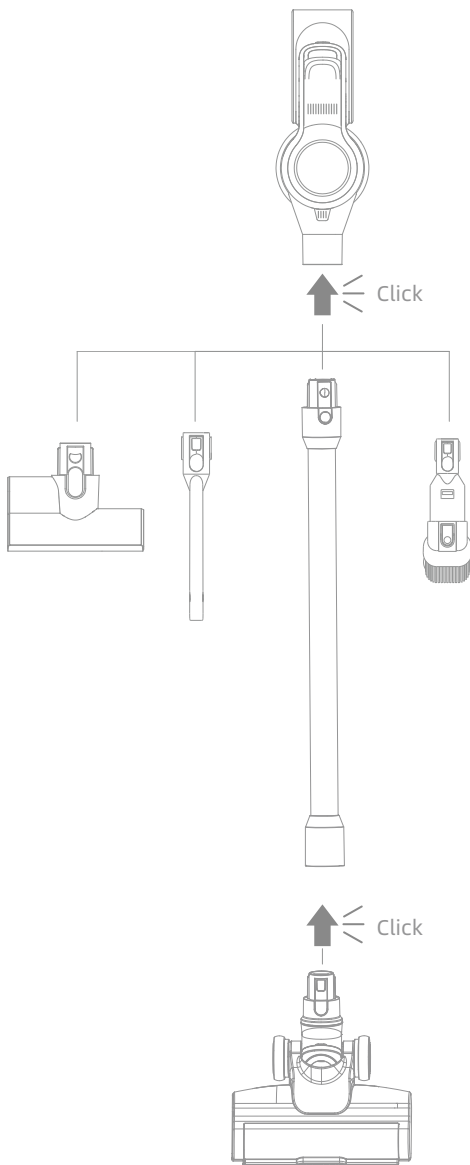

Installation

Wall Mount Installation Diagram

1. Wall mount should be level and at least 87cm (34.25") from the ground.
2. Use a power drill with an 8 mm drill bit to drill a hole into each marker on the mounting template sticker, then insert a wall plug into each hole.
3. Align the locating holes on the mount with the holes on the wall. Fasten it to the wall with the included screws.

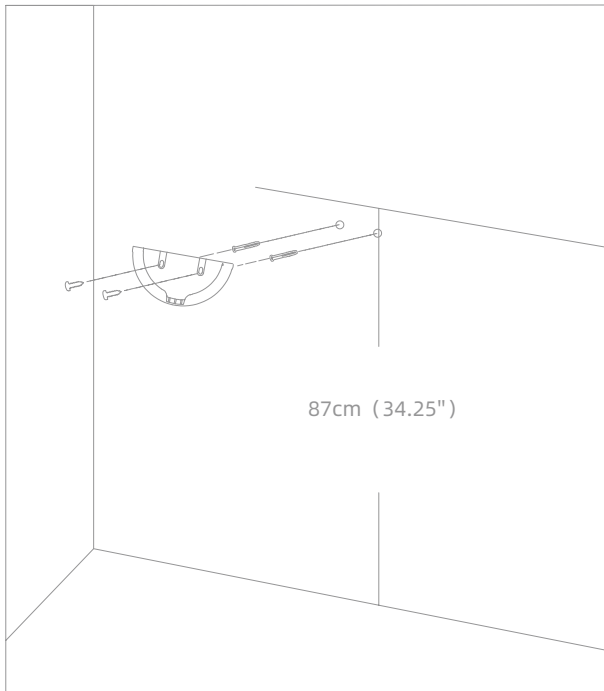

Note:

- Wall mount is an optional accessory. You can install it based on your needs.
- Wall mount should be installed in a cool, dry place. Prior to installing, ensure that there are no electrical wires or pipes in the space directly behind where the mount will be installed.

Charging

Note:

- Keep power off during charging, and do not take out the battery pack when connecting the vacuum body for arging, which will take about 4.5 hours.
- For initial use, this product shall be charged and discharged for 1-3 times, so that the battery activity can be fully activated.
- The socket of the power cord can be adjusted according to the user's needs.

Charging Method

Install the battery pack on the vacuum and charge it with the charger.

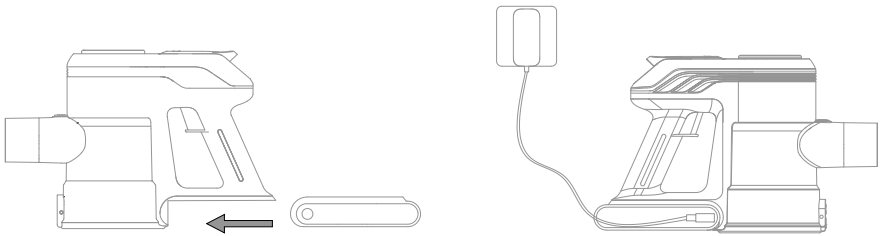

Battery Status Display

Display Screen

The number on the display screen represents the current battery level in a percentage during charging. When the number becomes 100, the battery is fully charged.

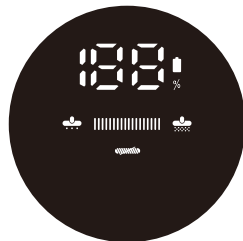

How to Use

Used as a vertical vacuum cleaner

- Open the extension rod and straighten it.
- Align the extension rod with the illumination multi-surface brush connector, and buckle it in place.
- Clip the suction end of the vacuum body down into the connecting end of the extension rod, and buckle it in place.
- Tilt the vacuum body backward, press the power button, and push the vacuum cleaner forward and backward to make it start working; press the power button again to make it stop working.

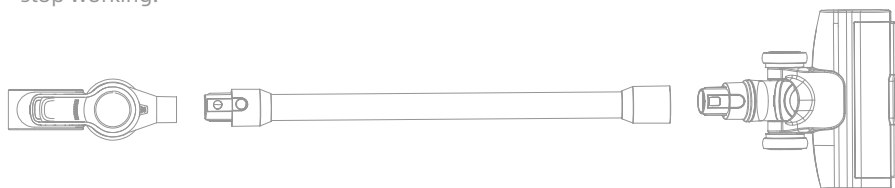

Used as a handheld vacuum cleaner

As required, the vacuum body can be connected with a crevice nozzle, wide combination tool, illumination multi-surface brush, and motorized minibrush used as a handheld vacuum cleaner.

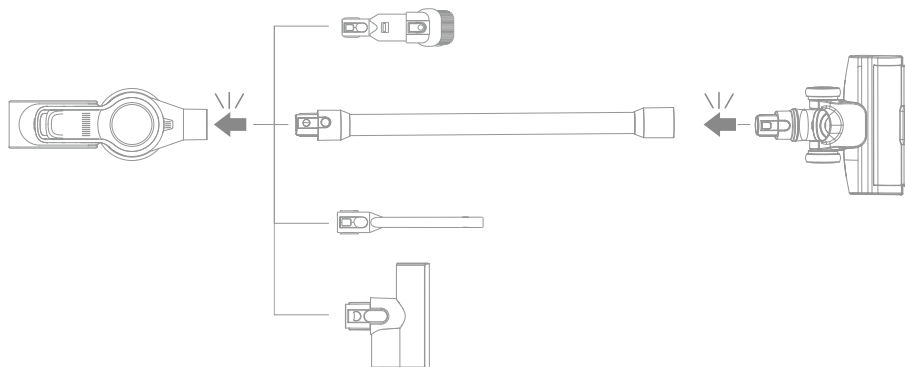

Startup for use

The energy-saving mode is as default for startup. Press " " " " on the display screen.

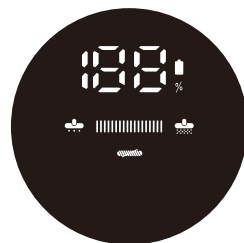

Note:

During operation, the display screen shows the current battery level and current gear level. When the battery level is lower than 20, please charge in time.

How to Use

Using Different Accessories

Illumination multi-surface brush

While the illumination multi-surface brush is working, the LED light at the front end is turned on, facilitating its use in a dark environment.

Note:

- When used for auxiliary dust vacuuming, the illumination multi-surface brush constantly rotates at high speed, so that please do not stay at a same place for too long, otherwise the floor surface may be damaged. There is an over current protection function provided at the end of illumination multi-surface brush. If the illumination multi-surface brush is wound or blocked, the preset protection program will cut off the power supply, the illumination multi-surface brush will stop running, and the 3 capacity indicators will flash all the time. At this point, please shut down the machine immediately, remove the battery pack, check and clean the illumination multisurface brush, remove the blockage, and then load back the battery pack and start the machine for reuse.

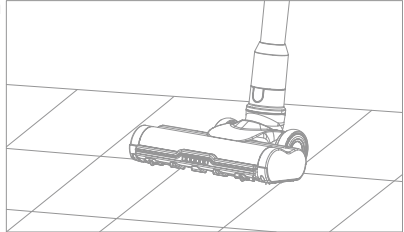

Wide combination tool

It can be used to vacuum the dust from desktops, keyboards, sofa gaps, household appliances, and other surfaces.

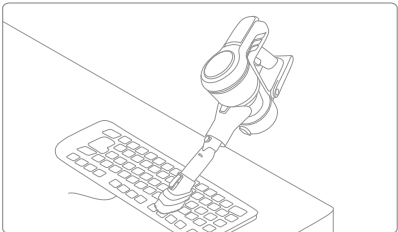

Crevice nozzle

Applicable to cleaning dust at wall corners, gaps, door and window corners, and shallow and narrow places.

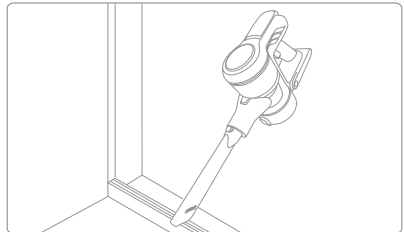

Motorized mini-brush

Used as a tool for cleaning household carpets, sofa, mattresses, etc., an electric motor with high-speed rotation can quickly and effectively remove dust, bacteria, mites and other dirt from carpets and furniture surfaces.

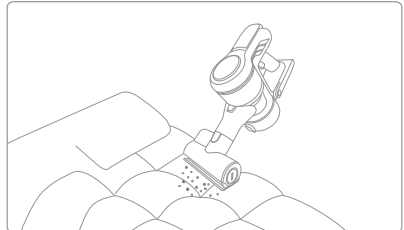

Note:

- Before installing and replacing accessories, power off the vacuum cleaner.
- This product cannot keep itself upright without fixed support. For storage, the machine and the accessories shall be stably placed.

Care & Maintenance

Tips:

- Always use genuine parts to avoid voiding the warranty.
- If the filter is clogged, the vacuum cleaner will stop functioning shortly after it is turned on. Please clean up the filter to restore the function. Before cleaning the dust cup, please verify that the plug has been disconnected and the power button of the vacuum cleaner has been left in the "OFF" position.
- If the vacuum cleaner is not used for a long time, please fully charge it, unplug the power cord, take out the battery, and store it in a cool and low -humidity environment, avoiding direct sunlight. To avoid excessive battery discharging, please charge the battery at least once every three months.

Cleaning the dust cup, air inlet filter, and cyclone separator assembly

1. Press the dust cup release button, and remove the cup from the vacuum cleaner.
2. Hold the separator, and rotate it clockwise to remove it from the vacuum cleaner.

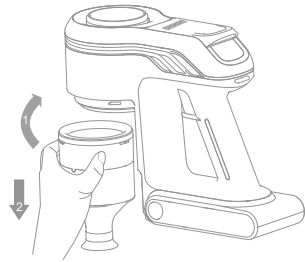
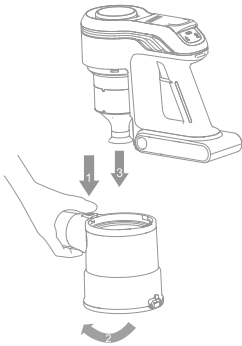

3. Remove the air inlet filter from the cyclone separator.
4. Rinse the cyclone assembly, air inlet filter, and dust cup until they are clean. After cleaning, dry it by air for at least 24 hours.

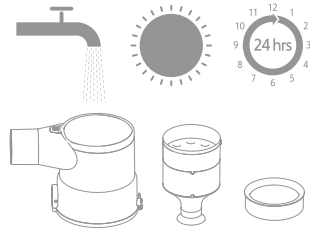

Attention: Please clean the dust cup as required. It is recommended to clean the cyclone system and air inlet filter at least once every 3-4 months.

Care & Maintenance

Installation of dust cup, air inlet filter, and cyclone separator assembly

1. Put the inlet filter back into the cyclone separator.



2. Hold the cyclone separator, and rotate it counterclockwise onto the vacuum cleaner.

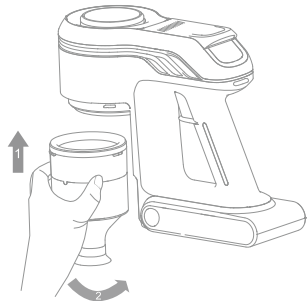

3. Align the dust cup with the slot on the vacuum cleaner, and rotate it slowly until the dust cup clicks into place.

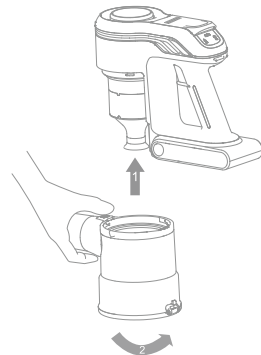

Care & Maintenance

Cleaning air outlet filter

1. Open the cover plate of air outlet filter.

2. Take out the air outlet filter.

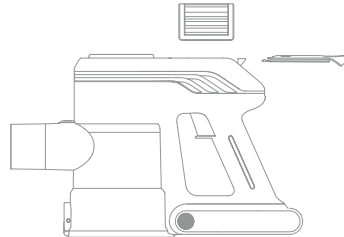
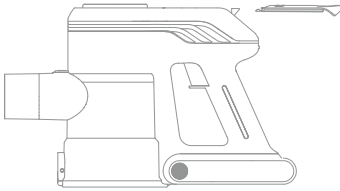

3. Rinse the air outlet filter with clean water, and after it is cleaned, dry it by air for at least 24 hours.

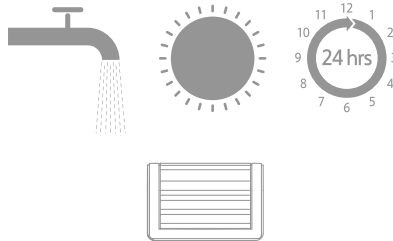

Note:

- It is recommended to clean the filter once every 4 to 6 months.
- Only use clean water to wash the filter. Do not use detergent.
- Do not attempt to clean the filter with a brush or finger.

Care & Maintenance

Cleaning illumination multi-surface brush

1. Toggle the lock knob of the roller brush in the arrow direction and lift the roller pressing plate at the same time, and then take out the roller brush.
2. Cut off the hair and fiber adhering to the brush roller with scissors, and wipe up the dust from the groove and transparent cover with dry cloth or tissue. Wipe it up completely before use.

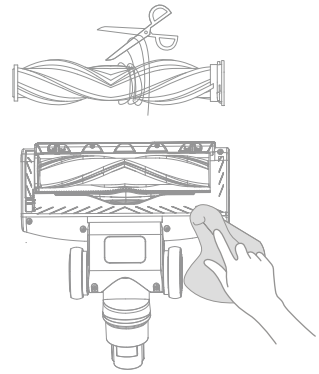
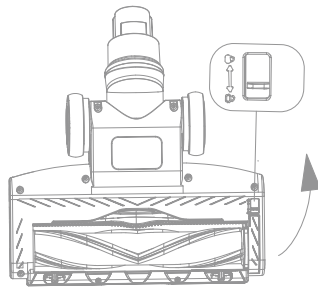

3. Rinse the brush roller, if it is dirty, with clean water until it is clean.
4. Stand the brush roller upright for at least 24 hours until it is dry completely.

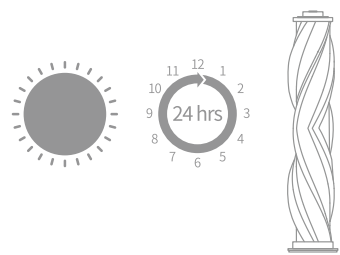
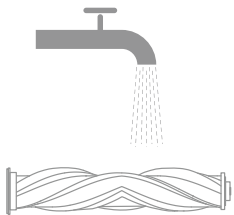

Care & Maintenance

Cleaning motorized mini-brush

1. Use a coin to turn the lock counterclockwise until you hear click, then pull out the roller brush.

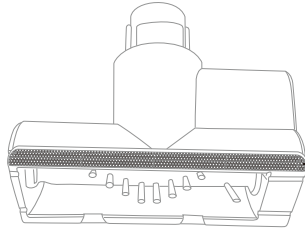
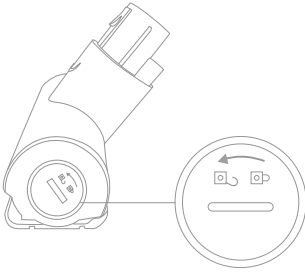

2. Use scissors to cut and pick out any hair or other debris tangled around the roller brush. Wipe the slot and transparent cover with dry cloth or tissue.

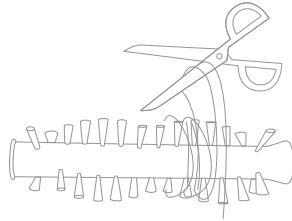

3. When it is dirty, rinse the roller with clean water until it is clean.

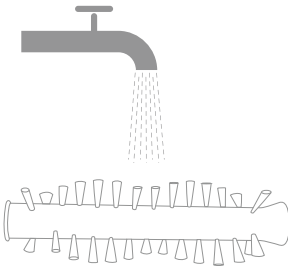

4. Stand the roller upright for at least 24 hours until it is completely dry.

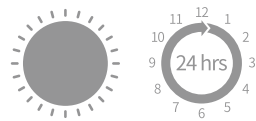

Specifications

Vacuum Body			
Model	VJ74E	Charging Time	Approximately 4.5 hours
Rated Power	450 W	Rated Voltage	25.9 V $\overline{\text{---}}$
Illumination Multi-Surface Brush			
Model	VSBW		
Rated Power	25 W	Rated Voltage	25.9 V $\overline{\text{---}}$
Rechargeable Lithium-Ion Battery Pack			
Model	HC-21Y-1	Nominal Voltage	25.9 V $\overline{\text{---}}$
Rated Capacity	2500 mAh		
Energy	64.75 Wh		
Motorized Mini-Brush			
Model	VMM3		
Rated Power	15 W	Rated Voltage	25.9 V $\overline{\text{---}}$

The lithium-ion pack contains substances that are hazardous to the environment. Before disposing of the vacuum, please remove the battery pack, then discard or recycle it in accordance with local laws and regulations of the country or region it is used in.

The appliance must be disconnected from the power supply when removing the battery. Keep batteries out of the reach of children. Never put batteries in mouth. If swallowed, contact your physician or local poison control.

Under abusive conditions, never contact the battery from which the liquid may be ejected. If contact accidentally occurs, rinse with water. If liquid contacts eyes, seek medical help immediately. Liquid ejected from the battery may cause irritation or burns.

FAQ

Important note

When the vacuum cleaner works abnormally, please turn off the appliance and cut off the power!

Errors	Possible causes	Troubleshooting method
The appliance cannot start, and the power indicator light flickers for several times and then goes out automatically	Low battery power	Charge the product
The vacuum cleaner has no suction power or little suction power	The dust cup is full	Empty the trash in the dust cup
	The dust cup or separator filter is not installed correctly	Reinstall the dust cup or separator filter properly
There is an obvious dust leak from the vacuum cleaner	The dust cup is full	Empty the trash in the dust cup
	The dust cup or separator filter is not installed correctly	Reinstall the dust cup or separator filter properly
The roller brush stops rotating, the power indicator light keeps flickering, and the appliance shuts down automatically 30 seconds later	The roller brush gets entangled or stuck, and the protection device starts up	Clean the entanglements in the floor brush
The air duct or dust cup filter element is blocked, the machine stops working, the indicator light keeps flickering, and the machine automatically shuts down 30 seconds later	Too many or too large particles of garbage are inhaled in	Clean up the air duct and filter element of the machine
The service time is shortened after charging	The charging time is insufficient	Please charge the product fully
	The battery is aged	Purchase an original battery to replace

Troubleshooting

If the vacuum is not working properly, the screen display will show an error message. Please refer to the troubleshooting table to find your solution.

Error Icon	Status	Error Message	Solutions
	Blinking Red	Roller brush stuck	Refer to the maintenance guide [Cleaning the illumination multi-surface brush] section to clean the fiber material and hairs wrapped around the brush roller.
If one of the error codes from E2/E6/E7 appears on the display, please contact the after-sales service team for repair.			